

BRYANT®



Cam-Type Devices and Power Distribution Boxes



Temporary Electrical Power Solutions
for Demanding Applications and Environments



BRYANT®
www.bryant-electric.com



Cam-Type Devices

Features and Benefits

Bryant offers a complete line of high quality, Cam-Type plugs, receptacles and accessories. The Bryant Cam-Type device line is rated for 600 volts AC and 250 volts DC, up to 400 amps. Accepts cable sizes #4 through 4/0. Cam-Type devices are the right choice for supplying temporary electrical power distribution for convention centers, entertainment, theme parks, carnival equipment, concerts, movie making, and numerous other applications requiring temporary power. Bryant Cam-Type devices have been designed with ease of assembly and disassembly in mind, no special tools are required. A high strength non-conductive retaining screw is all that is needed to securely lock the contacts to the insulated sleeve.



Male Plug

Ergonomic Housing for Superior Gripping

Grip conforms to the user's hand making it easy to connect and disconnect, even with gloves on.

Non-Conductive Retaining Screw Locks Contacts In Place

Allows for easy installation. Prevents contact movement within housing. Special screw thread requires fewer turns than most competitors and reduces the risk of a conductive screw being substituted.

Large Raised Alignment Arrow

Aids in the mating of devices and provides a visual indication that the devices are properly connected.



HBL300MBK

Rounded Corners

Reduces the possibility of catching or snagging on structures or equipment.

UL Enclosure Types 3R, 4X and 12K Rating

Suitable for use in almost any environment.

Double Cam Design With Stress Relief Hole

Provides high contact pressure and vibration resistant connection, which helps reduce operating temperatures and extends life.

Female Plug

High Conductivity Brass Contact

Provides improved performance by helping to reduce operating temperatures and extends life.

Turn and Lock Symbol

Aids in the mating of devices and provides a clear indication that the devices are properly connected.

Easily Identifiable Cable

Cut Off Points For Secure Fit

Allows you to easily customize the housing to the required cable size. Makes cutting to the correct cable size very easy. Accommodates wide range of cables (0.46" – 1.02").



HBL300FBK

Extra Long Locking Ring

Non-conductive inner sleeve reduces force required to install housing over contacts. Easier to rotate contact in body for installing retaining screw.

Strip Gauge

Molded into every plug and receptacle housing. Simplifies installation and saves time.



Cam-Type Devices

300 and 400 Ampere, 600V AC/250V DC

Plugs

Description	Color	300 Amp; #4-2/0 Cable Size		400 Amp; 2/0 - 4/0 Cable Size	
		Male Plug	Female Plug	Male Plug	Female Plug
Thermoplastic elastomer plugs.	Black	HBL300MBK	HBL300FBK	HBL400MBK	HBL400FBK
	Blue	HBL300MBL	HBL300FBL	HBL400MBL	HBL400FBL
	Brown	HBL300MBN	HBL300FBN	HBL400MBN	HBL400FBN
	Green	HBL300MGN	HBL300FGN	HBL400MGN	HBL400FGN
	Orange	HBL300MO	HBL300FO	HBL400MO	HBL400FO
	Red	HBL300MR	HBL300FR	HBL400MR	HBL400FR
	White	HBL300MW	HBL300FW	HBL400MW	HBL400FW
	Yellow	HBL300MY	HBL300FY	HBL400MY	HBL400FY



HBL400MBK



HBL400FBK

Receptacles, Stud Type

Description	Color	Female Receptacles		Male Receptacles	
		Through Hole Mounting	Threaded Mounting Holes	Through Hole Mounting	Threaded Mounting Holes
400 Amp Panel Mount, thermoplastic elastomer, mates with 300 and 400 Amp plugs.	Black	HBLFRSBK	HBLFRSCBK	HBLMRSBK	HBLMRSCBK
	Blue	HBLFRSBL	HBLFRSCBL	HBLMRSBL	HBLMRSCBL
	Brown	HBLFRSBN	HBLFRSCBN	HBLMRSBN	HBLMRSCBN
	Green	HBLFRSGN	HBLFRSCGN	HBLMRSGN	HBLMRSCGN
	Orange	HBLFRSO	HBLFRSCO	HBLMRSO	HBLMRSCO
	Red	HBLFRSR	HBLFRSCR	HBLMRSR	HBLMRSCR
	White	HBLFRSW	HBLFRSCW	HBLMRSW	HBLMRSCW
	Yellow	HBLFRSY	HBLFRSCY	HBLMRSY	HBLMRSCY



HBLFRSBL



HBLMRSR

Receptacles, Double Set Screw

Description	Color	Female Receptacles	Male Receptacles
400 Amp Panel Mount, thermoplastic elastomer, cable size #4 - 4/0, mates with 300 and 400 Amp plugs.	Black	HBLFRBK	HBLMRBK
	Blue	HBLFRBL	HBLMRBL
	Brown	HBLFRBN	HBLMRBN
	Green	HBLFRGN	HBLMRGN
	Orange	HBLFRO	HBLMRO
	Red	HBLFRR	HBLMRR
	White	HBLFRW	HBLMRW
	Yellow	HBLFRY	HBLMRY



HBLFRO



HBLMRBK

Protective Caps and Snap Back Covers

Description	Color	Fits Male Devices	Fits Female Devices	Use with Receptacles with:	
				Through Hole Mounting	Threaded Mounting Hole
Fits 300 and 400 Amp devices.	Black	HBLMCAPBK	HBLFCAPBK	HBLSCBK*	HBLSCCBK*
	Blue	HBLMCAPBL	HBLFCAPBL	HBLSCBL*	HBLSCCBL*
	Brown	HBLMCAPBN	HBLFCAPBN	HBLSCBN*	HBLSCCBN*
	Green	HBLMCAPGN	HBLFCAPGN	HBLSCGN*	HBLSCCGN*
	Orange	HBLMCAPO	HBLFCAPO	HBLSCO*	HBLSCCO*
	Red	HBLMCAPR	HBLFCAPR	HBLSCR*	HBLSCCR*
	White	HBLMCAPW	HBLFCAPW	HBLSCW*	HBLSCCW*
	Yellow	HBLMCAPY	HBLFCAPY	HBLSCY*	HBLSCCY*

Note: * 3R only.



HBLMCAPBK



HBLFCAPBK

HBLSCCW



Cam-Type Devices

300 and 400 Ampere, 600V AC/250V DC

"T's"

Color	Tapping "T" (Female-Female-Male)	Paralleling "T" (Female-Male-Male)
Black	HBLTBK	HBLPTBK
Blue	HBLTBL	HBLPTBL
Brown	HBLTBN	HBLPTBN
Green	HBLTGN	HBLPTGN
Orange	HBLTO	HBLPTO
Red	HBLTR	HBLPTR
White	HBLTW	HBLPTW
Yellow	HBLTY	HBLPTY



HBLTBN



HBLPTY

Tri-Taps

Color	Tri-Tap (Male-Female-Female-Female)	Tri-Tap (Female-Male-Male-Male)
Black	HBLM3FBK	HBLF3MBK
Blue	HBLM3FBL	HBLF3MBL
Brown	HBLM3FBN	HBLF3MBN
Green	HBLM3FGN	HBLF3MGN
Orange	HBLM3FO	HBLF3MO
Red	HBLM3FR	HBLF3MR
White	HBLM3FW	HBLF3MW
Yellow	HBLM3FY	HBLF3MY



HBLM3FBK



HBLF3MR

Gender Reversing Devices

Color	Double Male (Male-Male)	Double Female (Female-Female)
Black	HBLDMBK	HBLDFBK
Blue	HBLDMBL	HBLDFBL
Brown	HBLDMBN	HBLDFBN
Green	HBLDMGN	HBLDFGN
Orange	HBLDMO	HBLDFO
Red	HBLDMR	HBLDFR
White	HBLDMW	HBLDFW
Yellow	HBLDMY	HBLDFY



HBLDMBL



HBLDFBK

Distribution Block (1-Male, 6-Females)

Color	Catalog Number
Black	HBL7DBBK
Blue	HBL7DBBL
Brown	HBL7DBBN
Green	HBL7DBGN
Orange	HBL7DBO
Red	HBL7DBR
White	HBL7DBW
Yellow	HBL7DBY



HBL7DBGN

Replacement Bodies

Color	Male Body	Female Body
Black	HBLMBBK	HBLFBBK
Blue	HBLMBBL	HBLFBBL
Brown	HBLMBBN	HBLFBBN
Green	HBLMBGN	HBLFBGN
Orange	HBLMBO	HBLFBO
Red	HBLMBR	HBLFBR
White	HBLMBW	HBLFBW
Yellow	HBLMBY	HBLFBY



HBLMBBK



HBLFBBK



HBL300RCM



HBL300RCF

Replacement Contacts

Size	Male Pin	Female Sleeve
Contact, 300 Amp	HBL300RCM	HBL300RCF
Contact, 400 Amp	HBL400RCM	HBL400RCF

Accessory Kit

Description	Male or Female Plugs
Retaining Screw, Copper Foil, Terminal Screws and Wire.	HBLPK
Replacement retaining screw (500 pack).	HBLRS



HBLPK



Cam-Type Devices

300 and 400 Ampere, 600V AC/250V DC

Specifications

Electrical

Voltage Ratings	600V AC Maximum. 250V DC Maximum.
Amperage Rating	400A Maximum.

Mechanical

Terminal Accommodation	Plug- 300A - #4 to 2/0. Plug- 400A - 2/0 to 4/0. Recept.- 400A - #4 to 4/0.
Product Identification	Ratings are a permanent part of device.
Base Compound	Thermoplastic Elastomer (TPE).
Contact Material	Brass.
Retaining Screw Material	Nylon.

Certification / Environmental

UL and cUL Listed.
UL Enclosure Types 3R, 4X, 12K.
Flammability: HB per UL94 or CSA 22.2. 0.17.
UL 498 for attachment plugs and receptacles.
UL 1691 draft standard for single pin and sleeve devices intended for theatre, stage and studio applications.
National Electric Code (NEC), ANSI/NFPA 70.

Ampacity Chart (Type SC/PPC Wire)

Cable Size	Ampacity*
#4	140
#2	190
2/0	300
4/0	405

Note: * 90°C column NEC Table 400.5(B).

Dimensional Information

Male Plug

A	B	C	D
6.74" (171.2)	1.47" (37.3)	1.48" (37.6)	4.78" (121.4)

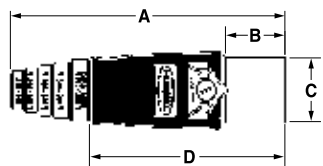

Panel Mount Receptacle; 1/2"-13 UNC Thread Stud

A	B	C	D	E	F	G
2.20" (55.9)	2.20" (55.9)	1.50" (38.1)	4.10" (104.3)	1.48" (37.6)	1.87" (47.4)	1.74" (44.2)
			3.67** (93.2)		1.61** (40.9)	1.55** (39.4)

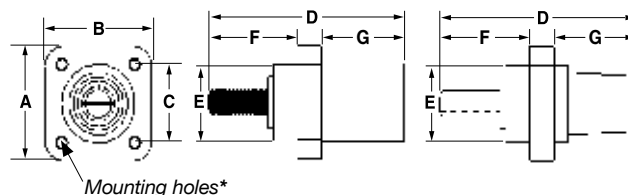

Tapping Tee

A	B	C
1.48" (37.6)	1.7" (43.3)	4.74" (120.5)

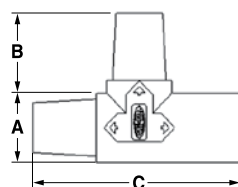

Note: * Receptacles with 10-32 threaded mounting holes.

Female Plug

A	B	C	D
6.84" (173.6)	1.44" (36.6)	1.06" (27.0)	4.80" (122.0)

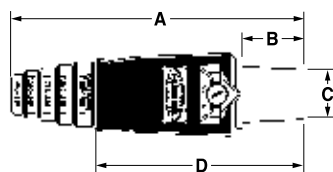

Panel Mount Receptacle; Double Set Screw

A	B	C	D	E
2.20" (55.9)	2.20" (55.9)	1.50" (38.1)	4.10" (104.3)	1.48" (37.6)

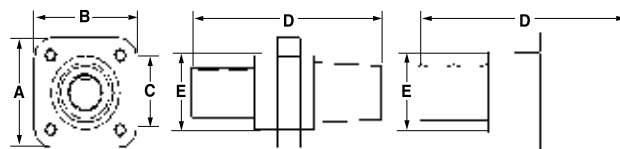

Single Pin TRI-TAP

A	B	C
5.88" (149.3)	5.78" (146.9)	1.48" (37.6)

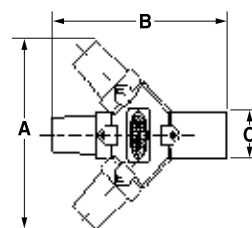

Double Male

A	B
4.65" (118.1)	1.48" (37.6)

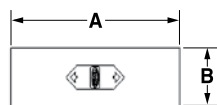

Double Female

A	B	C
4.84" (122.9)	1.44" (36.6)	1.06" (27.0)

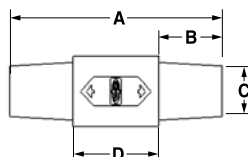

Snap Back Cover

A	B	C
2.26" (57.4)	2.33" (59.2)	1.62" (41.1)
		1.44*** (36.6)

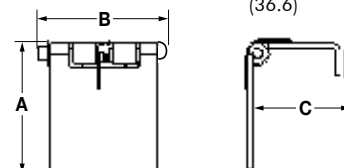

Note: ** Used with receptacles with threaded mounting holes.



Temporary Power Distribution Boxes

- Designed to address temporary power needs on construction sites and outdoor events
- Boxes are UL Type 3R for outdoor rainproof applications
- Weatherproof boots available for connecting plugs for additional protection from elements
- Bryant's Temporary Power Distribution Boxes meet NEC® 305.6 requirements for personal protection
- Listed to the latest UL 1640 standard for Portable Power Distribution Equipment



Weatherproof receptacle lift covers

Over current protection for each circuit

Individual GFCI module for each receptacle

Features 50A locking input and output

Available with six 20A straight blade or locking receptacles

Nested leg design allows boxes to be easily stacked

TPDLB

Construction Sites

- Renovations
- New Construction
- Demolition



Universities/Schools

- Graduation Ceremonies
- Concerts/Lectures
- Sporting Events



Stage/Theater

- Movie/Broadcasting
- Concerts
- Plays/Musicals



Outdoor Entertainment

- Carnivals
- Festivals
- Professional Sports





Temporary Power Distribution Boxes

Temporary Power Distribution Boxes

Rating	Type	Qty	Receptacle Ratings	Protection Overload	GFCI Protected	Catalog Number
50A, 120/240V AC (Max.)	Straight Blade	6	20A, 125V	Yes	Yes	TPDSB
	Locking	1	30A, 250V	Yes	No	
	Locking (inlet)	1	50A, 125/250V	No	No	
	Locking (outlet)	1	50A, 125/250V	No	No	
50A, 120/240V AC (Max.)	Locking	6	20A, 125V	Yes	Yes	TPDLB
	Locking	1	30A, 250V	Yes	No	
	Locking (inlet)	1	50A, 125/250V	No	No	
	Locking (outlet)	1	50A, 125/250V	No	No	



TPDLB

Cable Sets

Description	Catalog Number
50A cord set; 50 foot cable; 6/3, 8/1 cable type; with 50A locking plug and connector	TPC50B*
50A cord set; 100 foot cable; 6/3, 8/1 cable type; with 50A locking plug and connector	TPC100B*



TPC50B

Note: * Not UL Listed or CSA Certified.

Replacement Parts

Description	Catalog Number
20A, 125V straight blade receptacle	CRS20
30A, 250V locking receptacle	70530FR
50A, 125/250V locking receptacle	CS6369L
50A, 125/250V locking plug	CS6365L
50A, 125/250V locking connector	CS6364L
50A, 125/250V locking inlet	CS6375L
Weather protective plate for 20A receptacle	RW51470
Weather protective plate for 30A receptacle	7420B
Weather protective plate for 50A receptacle	7774CR
Weather protective plate for 50A inlet	7780



CRS20



CS6375L



7774CR

NEMA Type 1 Portable Outlet Boxes

Description	Catalog Number
Portable outlet box	3059BRY
Portable outlet box; deep	3099BRY
Portable outlet box with feed thru	3090FBRY
Portable outlet box with (2) duplex cover plates	3000BRY



3000BRY

NEMA Type 1 Portable Outlet Box Covers

Description	Catalog Number
Outlet box cover, duplex receptacle	3051BRY
Outlet box lift cover, duplex receptacle	3056BRY
Outlet box cover, 1.39" diameter receptacle	3052BRY
Outlet box lift cover, 1.39" diameter receptacle	3057BRY
Outlet box cover, 1.572" diameter receptacle	3053BRY
Outlet box lift cover, 1.572" diameter receptacle	3058BRY
Outlet box cover; GFCI	3060BRY
Outlet box lift cover; GFCI	3061BRY
Outlet box coverplate, blank	3054BRY



3056BRY



Temporary Power Distribution Boxes

Specifications

Boxes

Listings/Certifications	UL 1640, UL 943
Environment	Indoor and outdoor wet and dry locations
Enclosure type	3R, rainproof, suitable for use in damp locations
Code compliance	NEC®, ANSI/NFPA 70

Cables

Listings/Certifications	Connectors: UL/CSA; Cable: MSHA
Environment	Indoor and outdoor wet and dry locations

NEC® is a registered trademark of the National Fire Protection Association (NFPA).



Product Dimensions Inches (mm)

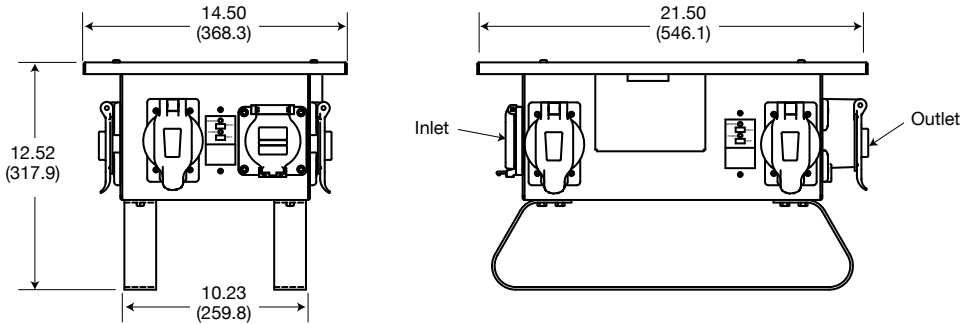

Also Available from Bryant

<p>Locking Wiring Devices</p> <p>With singularly rated NEMA and Non-NEMA locking wiring devices up to 60A, Bryant has the most extensive range of locking device configurations, including midget and power-interrupting designs. Weather-resistant boots also available.</p>	<p>IEC Pin & Sleeve</p> <p>Availability from 16A to 125A, these singularly rated, IP67 suitable watertight devices are ideal for wash-down and outdoor applications. Mechanical interlocks, back boxes, and accessories also available.</p>	<p>Watertight Devices</p> <p>Designed with superior impact and corrosion resistance, Bryant's extensive line of NEMA 4, 4X, 6, and 6P straight blade and locking watertight devices improve on the industry standard. Portable outlet boxes and weather protective covers are also available.</p>	<p>Economy® Grips and Mesh</p> <p>Economy® Cable Grips give you the advantage of selecting all your wire management strain relief, support, and pulling products from a respected, leading brand.</p>
<p>Corrosion-Resistant Devices</p> <p>Available in locking and straight blade configurations, these devices provide extra protection in corrosive conditions and temporary power situations for industrial, commercial, and marine environments; molded in high visibility yellow nylon for easy identification.</p>	<p>PlugBox® Lockout/Tagout</p> <p>Suitable for straight blade, locking, and pin and sleeve plugs and connectors, Bryant's PlugBox® devices provide an assured method of complying with OSHA lockout/tagout regulation.</p>	<p>Weatherproof Covers</p> <p>Covers are designed for use whenever weatherproof protection is required while an outlet is in use - line includes one and two gang covers with standard and extra deep depths.</p>	<p>GFCI Line Cords</p> <p>Portable GFCI Line Cords provide ground fault protection both indoors and out. Available in either manual or automatic set in a variety of lengths and outlet configurations.</p>



www.bryant-electric.com

